

抑制浪涌电流NTC热敏电阻器

Inrush Current Limiting NTC Thermistor (NTC)

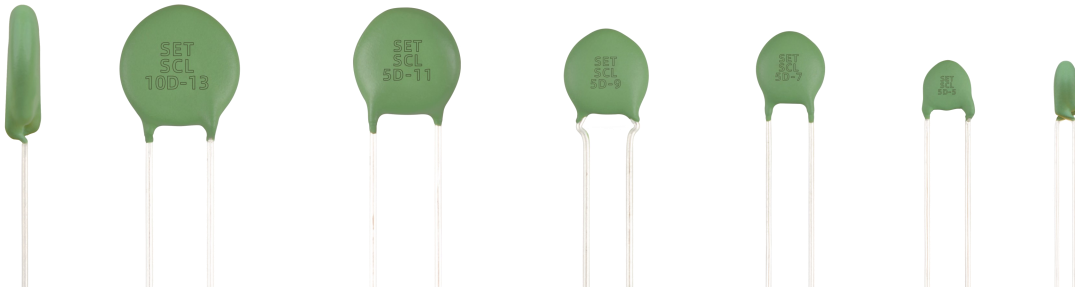
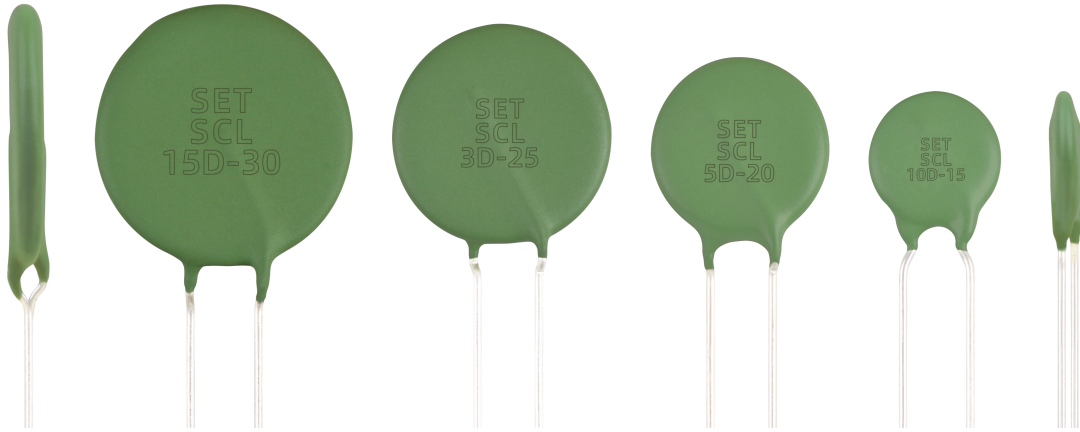

优点

- 快速响应
- 抑制浪涌能力强
- 高稳定电气特性
- 材料常数（B值）大，残余电阻小
- 新型陶瓷材料和均匀化工艺，体积效率高，性能好

Benefits

- Fast Response
- Strong Surge Suppression Capability
- High Stable Electrical Characteristics
- The Material Constant (B value) is Large and the Residual Resistance is Small
- New Ceramic Material and Homogenization Process for Volume-efficient & High-performance Design

抑制浪涌电流NTC热敏电阻器

Inrush Current Limiting NTC Thermistor (NTC)

抑制浪涌电流NTC热敏电阻器特性与型号概览

Inrush Current limiting NTC thermistor Feature & Model List Overview

标称零功率电阻值 Nominal Zero-power Resistance R_{25} (Ω)	D-5		D-7		D-9		D-11		D-13		页码 Page
	I_{max25} (A)	Model	I_{max25} (A)	Model	I_{max25} (A)	Model	I_{max25} (A)	Model	I_{max25} (A)	Model	Series
	220.0	0.5	220D-5	0.8	220D-7	1	220D-9	1	220D-11	1.5	220D-13
150.0	0	0	0	0	0	0	1	150D-11	0	0	
120.0	0.7	120D-5	1	120D-7	1	120D-9	1.5	120D-11	2	120D-13	
100.0	0.7	100D-5	1	100D-7	1	100D-9	1.5	100D-11	2	100D-13	
80.0	0.7	80D-5	1	80D-7	1	80D-9	1.5	80D-11	2.5	80D-13	
60.0	1	60D-5	1	60D-7	1	60D-9	2	60D-11	2.5	60D-13	
55.0	0	0	0	0	0	0	0	0	0	0	
50.0	1	50D-5	1.3	50D-7	2	50D-9	2	50D-11	3	50D-13	
47.0	1	47D-5	1.3	47D-7	2	47D-9	2	47D-11	3	47D-13	
40.0	1	40D-5	1.3	40D-7	2	40D-9	2	40D-11	3	40D-13	
33.0	1.3	33D-5	1.3	33D-7	2	33D-9	2.5	33D-11	3	33D-13	
30.0	1.3	30D-5	1.3	30D-7	2	30D-9	2.5	30D-11	3	30D-13	
25.0	1.3	25D-5	1.5	25D-7	2	25D-9	2.5	25D-11	3	25D-13	
22.0	1.3	22D-5	1.5	22D-7	2	22D-9	3	22D-11	4	22D-13	
20.0	1.3	20D-5	1.5	20D-7	2	20D-9	3	20D-11	4	20D-13	
18.0	1.5	18D-5	1.5	18D-7	2	18D-9	3	18D-11	4	18D-13	
16.0	1.5	16D-5	1.5	16D-7	2.5	16D-9	3	16D-11	4	16D-13	
15.0	1.5	15D-5	2	15D-7	2.5	15D-9	3	15D-11	4	15D-13	
14.0	0	0	0	0	0	0	0	0	0	0	
13.0	1.5	13D-5	2	13D-7	3	13D-9	0	0	0	0	
12.0	1.5	12D-5	2	12D-7	3	12D-9	4	12D-11	5	12D-13	
10.0	2	10D-5	2	10D-7	3	10D-9	4	10D-11	5	10D-13	
8.0	2	8D-5	2.5	8D-7	3	8D-9	4	8D-11	5	8D-13	
7.0	2	7D-5	3	7D-7	3	7D-9	4	7D-11	5	7D-13	
6.8	2	6.8D-5	3	6.8D-7	3	6.8D-9	4	6.8D-11	5	6.8D-13	
6.0	2	6D-5	3	6D-7	4	6D-9	4	6D-11	5	6D-13	
5.0	2	5D-5	3	5D-7	4	5D-9	5	5D-11	6	5D-13	
4.7	2.5	4.7D-5	3	4.7D-7	4	4.7D-9	5	4.7D-11	6	4.7D-13	
4.0	2.5	4D-5	3	4D-7	4	4D-9	5	4D-11	6	4D-13	
3.0	2.5	3D-5	3	3D-7	5	3D-9	6	3D-11	7	3D-13	
2.5	0	0	3.5	2.5D-7	5	2.5D-9	6	2.5D-11	8	2.5D-13	
2.2	0	0	4	2.2D-7	5	2.2D-9	6	2.2D-11	8	2.2D-13	
2.0	0	0	4	2D-7	5	2D-9	6	2D-11	8	2D-13	
1.5	0	0	4	1.5D-7	5	1.5D-9	7	1.5D-11	8	1.5D-13	
1.3	0	0	4.5	1.3D-7	5	1.3D-9	7	1.3D-11	8	1.3D-13	
1.0	0	0	0	0	5	1D-9	7	1D-11	8	1D-13	
0.7	0	0	0	0	0	0	8	0.7D-11	9	0.7D-13	
0.5	0	0	0	0	0	0	0	0	9	0.5D-13	
0.3	0	0	0	0	0	0	0	0	0	0	
0.2	0	0	0	0	0	0	0	0	0	0	
P_{max} (W) 最大功耗	1.0		1.4		2.0		2.4		3.0		
C_{max} (μ F) @240V 最大允许电容量	68		130		250		330		470		
产品结构 Product Structure											
	Y型脚 In-line Crimp Lead		内弯脚 Inward Crimp Lead		外弯脚 Outward Crimp Lead						

最大电流与型号
 I_{max25} & Model
环境温度
Ambient Temp. 25 °C

NTC

NTC

抑制浪涌电流NTC热敏电阻器

Inrush Current Limiting NTC Thermistor (NTC)

抑制浪涌电流NTC热敏电阻器特性与型号概览

Inrush Current limiting NTC thermistor Feature & Model List Overview

标称零功率电阻值 Nominal Zero-power Resistance R_{25} (Ω)	D-5		D-7		D-9		D-11		D-13		页码 Page
	I_{max25} (A)	Model	I_{max25} (A)	Model	I_{max25} (A)	Model	I_{max25} (A)	Model	I_{max25} (A)	Model	Series
	220.0	0.5	220D-5	0.8	220D-7	1	220D-9	1	220D-11	1.5	220D-13
150.0	0	0	0	0	0	0	1	150D-11	0	0	
120.0	0.7	120D-5	1	120D-7	1	120D-9	1.5	120D-11	2	120D-13	
100.0	0.7	100D-5	1	100D-7	1	100D-9	1.5	100D-11	2	100D-13	
80.0	0.7	80D-5	1	80D-7	1	80D-9	1.5	80D-11	2.5	80D-13	
60.0	1	60D-5	1	60D-7	1	60D-9	2	60D-11	2.5	60D-13	
55.0	0	0	0	0	0	0	0	0	0	0	
50.0	1	50D-5	1.3	50D-7	2	50D-9	2	50D-11	3	50D-13	
47.0	1	47D-5	1.3	47D-7	2	47D-9	2	47D-11	3	47D-13	
40.0	1	40D-5	1.3	40D-7	2	40D-9	2	40D-11	3	40D-13	
33.0	1.3	33D-5	1.3	33D-7	2	33D-9	2.5	33D-11	3	33D-13	
30.0	1.3	30D-5	1.3	30D-7	2	30D-9	2.5	30D-11	3	30D-13	
25.0	1.3	25D-5	1.5	25D-7	2	25D-9	2.5	25D-11	3	25D-13	
22.0	1.3	22D-5	1.5	22D-7	2	22D-9	3	22D-11	4	22D-13	
20.0	1.3	20D-5	1.5	20D-7	2	20D-9	3	20D-11	4	20D-13	
18.0	1.5	18D-5	1.5	18D-7	2	18D-9	3	18D-11	4	18D-13	
16.0	1.5	16D-5	1.5	16D-7	2.5	16D-9	3	16D-11	4	16D-13	
15.0	1.5	15D-5	2	15D-7	2.5	15D-9	3	15D-11	4	15D-13	
14.0	0	0	0	0	0	0	0	0	0	0	
13.0	1.5	13D-5	2	13D-7	3	13D-9	0	0	0	0	
12.0	1.5	12D-5	2	12D-7	3	12D-9	4	12D-11	5	12D-13	
10.0	2	10D-5	2	10D-7	3	10D-9	4	10D-11	5	10D-13	
8.0	2	8D-5	2.5	8D-7	3	8D-9	4	8D-11	5	8D-13	
7.0	2	7D-5	3	7D-7	3	7D-9	4	7D-11	5	7D-13	
6.8	2	6.8D-5	3	6.8D-7	3	6.8D-9	4	6.8D-11	5	6.8D-13	
6.0	2	6D-5	3	6D-7	4	6D-9	4	6D-11	5	6D-13	
5.0	2	5D-5	3	5D-7	4	5D-9	5	5D-11	6	5D-13	
4.7	2.5	4.7D-5	3	4.7D-7	4	4.7D-9	5	4.7D-11	6	4.7D-13	
4.0	2.5	4D-5	3	4D-7	4	4D-9	5	4D-11	6	4D-13	
3.0	2.5	3D-5	3	3D-7	5	3D-9	6	3D-11	7	3D-13	
2.5	0	0	3.5	2.5D-7	5	2.5D-9	6	2.5D-11	8	2.5D-13	
2.2	0	0	4	2.2D-7	5	2.2D-9	6	2.2D-11	8	2.2D-13	
2.0	0	0	4	2D-7	5	2D-9	6	2D-11	8	2D-13	
1.5	0	0	4	1.5D-7	5	1.5D-9	7	1.5D-11	8	1.5D-13	
1.3	0	0	4.5	1.3D-7	5	1.3D-9	7	1.3D-11	8	1.3D-13	
1.0	0	0	0	0	5	1D-9	7	1D-11	8	1D-13	
0.7	0	0	0	0	0	0	8	0.7D-11	9	0.7D-13	
0.5	0	0	0	0	0	0	0	0	9	0.5D-13	
0.3	0	0	0	0	0	0	0	0	0	0	
0.2	0	0	0	0	0	0	0	0	0	0	
P_{max} (W) 最大功耗	1.0		1.4		2.0		2.4		3.0		
C_{max} (μ F) @240V 最大允许电容量	68		130		250		330		470		
产品结构 Product Structure											
	Y型脚 In-line Crimp Lead		内弯脚 Inward Crimp Lead		外弯脚 Outward Crimp Lead		外弯脚 Outward Crimp Lead		外弯脚 Outward Crimp Lead		

最大电流与型号
 I_{max25} & Model
环境温度
Ambient Temp. 25 °C

NTC

NTC

抑制浪涌电流NTC热敏电阻器

Inrush Current Limiting NTC Thermistor (NTC)

产品描述 Description

抑制浪涌电流NTC热敏电阻器是用负温度系数的特殊半导体陶瓷材料制成的温度敏感性电阻器。它们在室温下有较高的电阻值，当它们通电时，由于自身发热使电阻体温度升高，电阻值下降。利用这一特性，它们被用作电气和电子设备的电流保护器件，这些器件容易有效地限制异常电流，包括通电时的浪涌电流。用作电流保护器件的NTC热敏电阻也称为功率型热敏电阻。

Inrush Current Limiting NTC Thermistor is a temperature sensitive resistor made of special semiconductor ceramic material with Negative Temperature Coefficient characteristics. It has a higher resistance value at room temperature, when they are energized, the temperature of the resistor body rises due to self-heating, and the resistance value drops. Using this feature, they are used as Inrush current limiting/protection components for electrical and electronic equipment. These devices can easily and effectively limit abnormal currents, including surge currents when energized. Inrush Current Limiting NTC Thermistors used as current protection devices are also called power thermistors.

应用 Applications

- 开关电源 Switch-mode Power Supplies
- 变压器 Transformers
- 逆变器 Inverters
- 软启动电机 Soft-start Motors
- LED驱动电路 LED Driver Circuit
- 卤素灯 Halogen Lamp

结构图 Structure

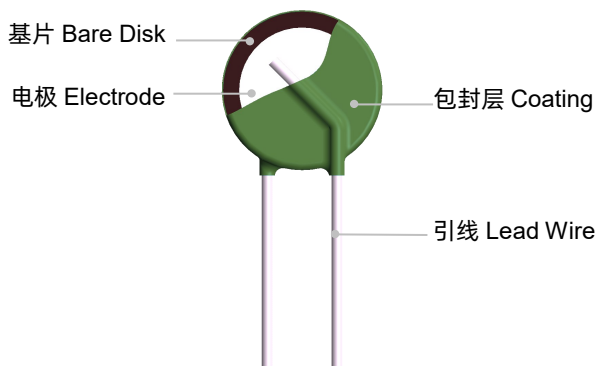

安规认证 Agency Approvals

认证信息 Agency Mark	标准 Standards	认证号 No.
	UL 1434	E519784
	IEC 60539-1	R 50514002
	GB_T 6663.1	CQC21001308813

抑制浪涌电流NTC热敏电阻器

Inrush Current Limiting NTC Thermistor (NTC)

编码规则 Part Numbering System

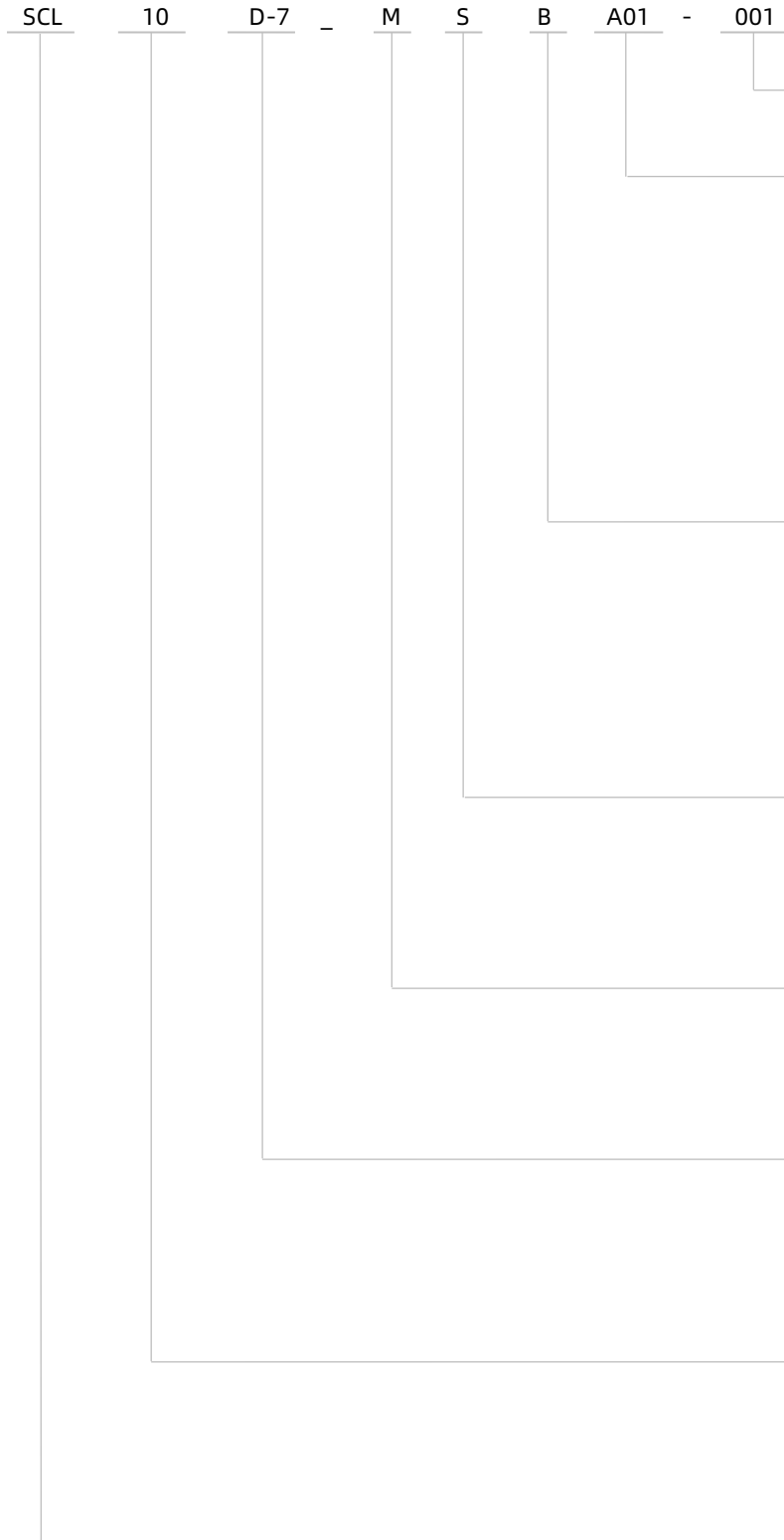

其它选项 Other Options

包装方式或脚长

A01 折叠包装 BN0 散装标准脚长
C35 散装脚长3.5 mm L10 散装脚长10 mm

Packing Mode or Lead Length:

A01: AMMO packing (P0=12.7 mm)
BN0: Bulk with standard length
C35: Bulk with length 3.5 mm
L10: Bulk with length 10 mm

脚型

A: 直脚 B: 内弯脚
C: 外弯脚 D: Y型脚

Lead Types

A: Straight Lead B: Inward Crimp Lead
C: Outward Crimp Lead D: Inline Crimp Lead

引线材质

S: 镀锡铜包钢线

Lead Wire Materials:

S: Tinned copper clad steel wire

R₂₅公差

R₂₅Tolerance:

K: ±10% L: ±15% M: ±20% N: ±25%

基片直径 Disk Diameter

D-5: Φ5 mm D-7: Φ7 mm D-9: Φ9 mm

D-11: Φ11 mm D-13: Φ13 mm D-15: Φ15 mm

D-20: Φ20 mm D-25: Φ25 mm D-30: Φ30 mm

标称零功率电阻值

Nominal Zero-power Resistance (R₂₅)

0.2: 0.2 Ω; 8: 8 Ω; 10: 10 Ω;

100: 100 Ω...

产品类别 Product Category

抑制浪涌电流NTC热敏电阻器

Inrush Current Limiting NTC Thermistor

NTC

NTC

抑制浪涌电流NTC热敏电阻器

Inrush Current Limiting NTC Thermistor (NTC)

术语 Glossary

项目 Item	描述 Description
R_{25}	<p>标称零功率电阻值 Nominal Zero-power Resistance</p> <p>25 °C标准参考温度下零功率电阻的标称值，除非另有规定。 Nominal value of zero-power resistance at the standard reference temperature of 25 °C, unless otherwise specified. — (IEC 60539)</p>
I_{max25}	<p>25 °C环境温度下的最大电流 Maximum Current at Ambient Temperature of 25 °C</p> <p>在25 °C的环境温度下，可连续施加到热敏电阻器上的电流（直流或交流正弦波的有效值）最大值。 Maximum value of current (d.c. or r.m.s. values for Sine wave shaped a.c.) which can be continuously applied to the thermistor at an ambient temperature of 25 °C. — (IEC 60539)</p>
B	<p>B 值 B value</p> <p>用以下公式表示热灵敏指数</p> $B = \frac{T_a \times T_b}{T_b - T_a} \times \ln \frac{R_a}{R_b}$ <p>R_a 在温度T_a（单位为K）下测定的零功率电阻值（单位为Ω） R_b 在温度T_b（单位为K）下测定的零功率电阻值（单位为Ω） $T_a = 298.15$ K, $T_b = 358.15$ K Index of thermal sensitivity expressed by the formula</p> $B = \frac{T_a \times T_b}{T_b - T_a} \times \ln \frac{R_a}{R_b}$ <p>R_a is the zero-power resistance (Ω) at temperature T_a (k) R_b is the zero-power resistance (Ω) at temperature T_b (k) $T_a = 298.15$ K, $T_b = 358.15$ K — (IEC 60539)</p>
δ	<p>耗散系数 Dissipation Factor</p> <p>使热敏电阻器的温度升高1K所需消耗的功率，通常为规定的环境温度下功耗变化与热敏电阻器阻体温度变化之比。 Power dissipation required for a thermistor to raise its temperature by 1 K and which is generally the ratio of the power dissipation change to the resulting thermistor body temperature change at a specified ambient temperature. — (IEC 60539)</p>
τ_a	<p>环境温度变化的热时间常数 Thermal Time Constant by Ambient Temperature Change</p> <p>热敏电阻器对规定介质中环境温度63.2%的外部阶跃变化作出响应所需的时间。 Time required for a thermistor to respond to 63.2 % of an external step change in ambient temperature in a defined medium. — (IEC 60539)</p>
$R_{min@I_{max25}}$	<p>残余电阻 Residual Resistance</p> <p>当热敏电阻器上流过最大电流并达到热平衡时的直流电阻值。 Inrush Current-limiting Thermistors value of the d.c. resistance of a thermistor when its thermal stability is reached with the maximum current passing. — (IEC 60539)</p>
C_{max}	<p>最大允许容量 Maximum Permissible Capacitance</p> <p>在负载状态下，与一个热敏电阻器连接的电容器的最大允许容量值。 Maximum permissible capacitance value of a capacitor which can be connected to a thermistor under loading. — (IEC 60539)</p>
P_{max}	<p>最大功耗 Maximum Power Dissipation</p> <p>在环境温度25°C下，可以连续施加在热敏电阻器上的最大功耗值。 Maximum value of the power dissipation which can be continuously applied to the thermistor at 25 °C. — (IEC 60539)</p>

NTC

NTC

抑制浪涌电流NTC热敏电阻器

Inrush Current Limiting NTC Thermistor (NTC)

最大电流降额曲线 Max. Current Derating Curve

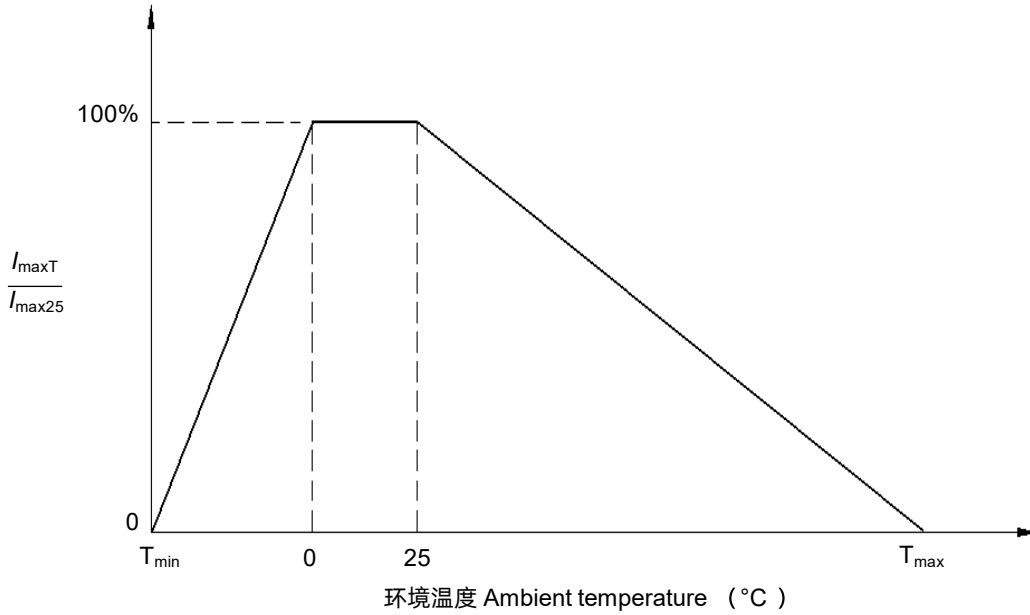

T_{max} : 最高工作温度 Maximum Operating Temperature (°C)

T_{min} : 最低工作温度 Minimum Operating Temperature (°C)

$$T_{min} < T < 0: I_{maxT} = \left[1 - \frac{0-T}{0-T_{min}} \right] \times I_{max25}$$

$$25 < T < T_{max}: I_{maxT} = \left[1 - \frac{T-25}{T_{max}-25} \right] \times I_{max25}$$

例如 For Example

T_{min} : -40 °C T_{max} : 175 °C

环境温度 Ambient Temperature (T) = -10 °C

$$\begin{aligned} I_{maxT} &= \left[1 - \frac{0-T}{0-T_{min}} \right] \times I_{max25} \\ &= 75\% I_{max25} \end{aligned}$$

环境温度 Ambient Temperature (T) = 60 °C

$$\begin{aligned} I_{maxT} &= \left[1 - \frac{T-25}{T_{max}-25} \right] \times I_{max25} \\ &= 77\% I_{max25} \end{aligned}$$

抑制浪涌电流NTC热敏电阻器

Inrush Current Limiting NTC Thermistor (NTC)

焊接参数 Soldering Parameters

1. 波峰焊参数 Wave Soldering Parameters

波峰焊参数仅供参考。热敏电阻器实际使用时，需要进行一些相关的验证。

The wave soldering parameters are for reference only. When thermistor is for practice use, some related validation is recommended.

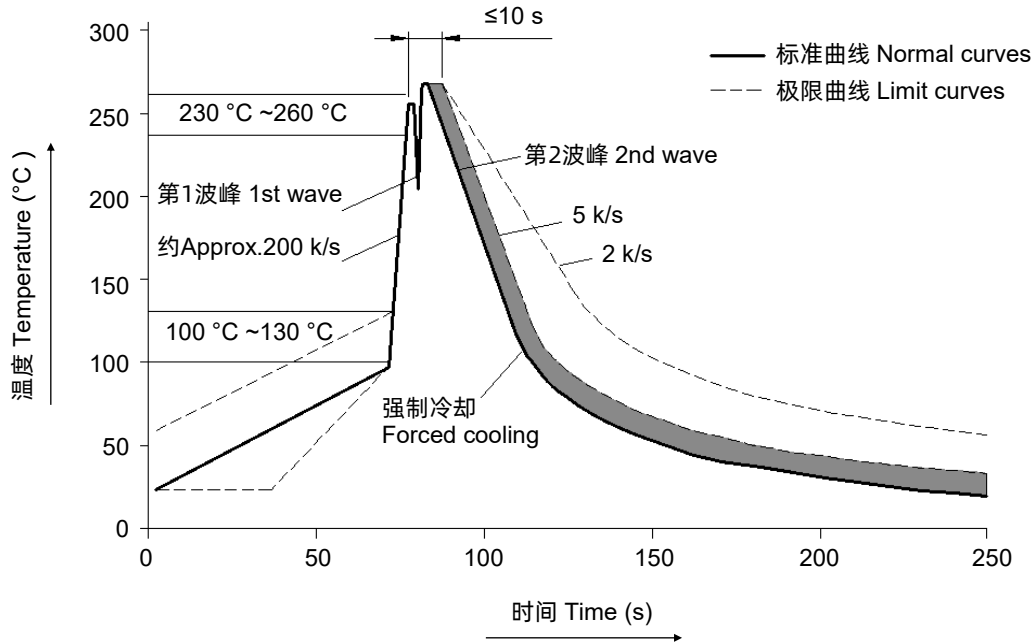

波峰焊曲线 Wave Soldering Curve

2. 推荐手工焊接参数 Recommended Hand-Solder Parameters

手工焊接，请注意焊接温度和焊接时间，建议如下：

For hand soldering, please notice the solder tip temperature and the soldering time, recommended as follows:

项目 Items	条件 Conditions
烙铁头部温度 Temp. of Solder Head	360 °C (max.)
焊接时间 Soldering Time	3 sec. (max.)
焊接位置与涂装层距离 Distance from Thermistor	2 mm (min.)

抑制浪涌电流NTC热敏电阻器

Inrush Current Limiting NTC Thermistor (NTC)



注意 ATTENTION

使用方法 Usage

1. 热敏电阻必须在规定的环境温度下使用。
Thermistor must be operated within the specified ambient temperature.
2. 不要用酮类、酯类、苯类、卤代烃等强极性溶剂清洗热敏电阻，以免损坏封装层。
Do not clean the thermistor with strong polar solvent such as ketone, esters, benzene, halogenated hydrocarbon, to avoid damaging the encapsulating layer.
3. 请不要强烈的振动、冲击或施加压力，以免热敏电阻表面树脂或元件产生开裂。
Please do not apply severe vibration, shock or pressure to thermistor, to avoid surface resin or element cracking.
4. 对引线进行弯曲加工或切断加工时，请固定元件端引线。折弯距离引线绝缘覆盖部分应大于2mm。
Please fix lead wires when bending or cutting. the distance between the bending point and the sealing of thermistor shall be greater than 2 mm.

更换 Replacement

1. 如果热敏电阻外观损坏，请更换。
If thermistor is visually damaged, please replace it.
2. 热敏电阻是一种不可修复的产品。为安全原因，替换时应使用同类别同型号的产品。
Thermistor is a non-repairable product. for safety sake, please use equivalent thermistor for replacement.

抑制浪涌电流NTC热敏电阻器

Inrush Current Limiting NTC Thermistor (NTC)

存贮 Storage

1. 仅在原包装中储存热敏电阻。储存前不要打开包装。
Storage thermistor only in original packaging. do not open the package before storage.
2. 储存温度：-25至45°C。
Storage temperature range: -25 to 45 °C.
3. 相对湿度：≤75%RH。
Relative humidity : ≤75% RH.
4. 避免腐蚀性气体和日光直射。
Keep away from corrosive gas and direct sunlight.
5. 贮存期限：≤1年。
Period of storage: ≤1 Year.

安装 Installation

装配时应避免出现如敲击等作业方式，避免造成产品出现机械损坏。

Do not take violent action such as knocking when assembling to avoid mechanical damage.

抑制浪涌电流NTC热敏电阻器

Inrush Current Limiting NTC Thermistor (NTC)

D-5系列 Series

尺寸 Dimensions

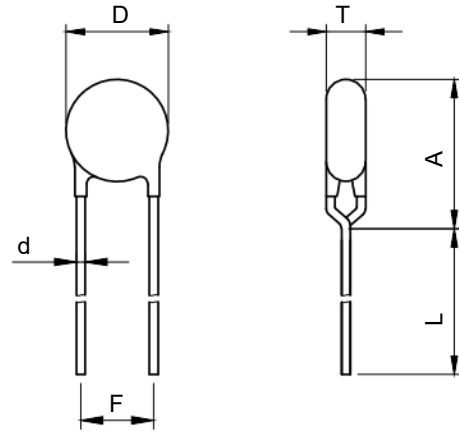
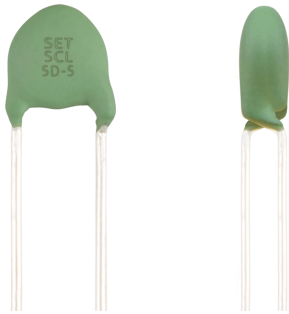

Y型引线 Inline Crimp Lead

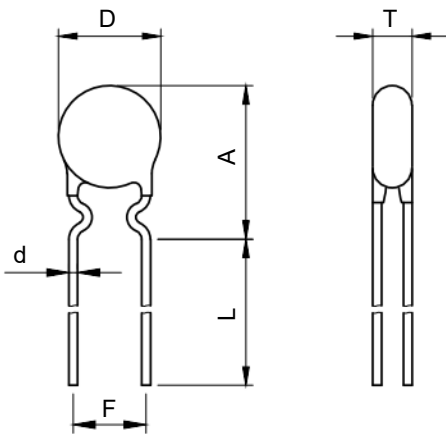

内弯型引线 Inward Crimp Lead

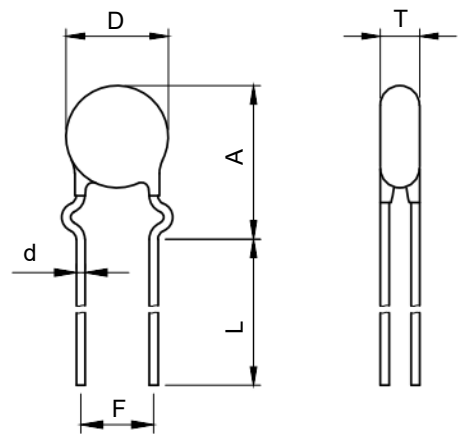

外弯型引线 Outward Crimp Lead

D Max.	F ± 1.0	d ± 0.05	A Max.	L Min.	T Max.
7.0	5.0	Φ0.6	11.0	20.0	5.0

注：可根据客户要求提供其它引线配置。
 Note: Alternative lead configurations available on request.

NTC

NTC

抑制浪涌电流NTC热敏电阻器

Inrush Current Limiting NTC Thermistor (NTC)

D-5系列 Series

电气参数 Electrical Specifications

型号 Model	R_{25}	I_{max25}	$B_{25/85}$	δ	τ_a	$R_{min}@I_{max25}$	C_{max}		P_{max}	工作温度范围 Operating Temperature Range
	(Ω)	(A)	(K)	(mW/K)	(s)	(Ω)	@120Vac (μ F)	@240Vac (μ F)	(W)	($^{\circ}$ C)
SCL3D-5	3	2.5	2600	≥ 6	≤ 20	0.15	272	68	1.0	-40 ~ +175
SCL4D-5	4	2.5	2600	≥ 6	≤ 20	0.16	272	68	1.0	-40 ~ +175
SCL4.7D-5	4.7	2.5	2600	≥ 6	≤ 20	0.17	272	68	1.0	-40 ~ 175
SCL5D-5	5	2.0	2600	≥ 6	≤ 20	0.24	272	68	1.0	-40 ~ 175
SCL6D-5	6	2.0	2700	≥ 6	≤ 20	0.24	272	68	1.0	-40 ~ 175
SCL6.8D-5	6.8	2.0	2700	≥ 6	≤ 20	0.26	272	68	1.0	-40 ~ 175
SCL7D-5	7	2.0	2700	≥ 6	≤ 20	0.26	272	68	1.0	-40 ~ 175
SCL8D-5	8	2.0	2700	≥ 6	≤ 20	0.27	272	68	1.0	-40 ~ 175
SCL10D-5	10	2.0	2700	≥ 6	≤ 20	0.29	272	68	1.0	-40 ~ 175
SCL12D-5	12	1.5	2800	≥ 6	≤ 20	0.43	272	68	1.0	-40 ~ 175
SCL13D-5	13	1.5	2800	≥ 6	≤ 20	0.45	272	68	1.0	-40 ~ 175
SCL15D-5	15	1.5	2800	≥ 6	≤ 20	0.47	272	68	1.0	-40 ~ 175
SCL16D-5	16	1.5	2800	≥ 6	≤ 20	0.48	272	68	1.0	-40 ~ 175
SCL18D-5	18	1.5	2900	≥ 6	≤ 20	0.47	272	68	1.0	-40 ~ 175
SCL20D-5	20	1.3	2900	≥ 6	≤ 20	0.60	272	68	1.0	-40 ~ 175
SCL22D-5	22	1.3	2900	≥ 6	≤ 20	0.62	272	68	1.0	-40 ~ 175
SCL25D-5	25	1.3	2900	≥ 6	≤ 20	0.64	272	68	1.0	-40 ~ 175
SCL30D-5	30	1.3	2900	≥ 6	≤ 20	0.68	272	68	1.0	-40 ~ 175
SCL33D-5	33	1.3	2900	≥ 6	≤ 20	0.70	272	68	1.0	-40 ~ 175
SCL40D-5	40	1.0	2965	≥ 6	≤ 20	1.04	272	68	1.0	-40 ~ 175
SCL47D-5	47	1.0	2965	≥ 6	≤ 20	1.10	272	68	1.0	-40 ~ 175
SCL50D-5	50	1.0	2965	≥ 6	≤ 20	1.12	272	68	1.0	-40 ~ 175
SCL60D-5	60	1.0	3065	≥ 6	≤ 20	1.14	272	68	1.0	-40 ~ 175
SCL80D-5	80	0.7	3065	≥ 6	≤ 20	2.05	272	68	1.0	-40 ~ 175
SCL100D-5	100	0.7	3065	≥ 6	≤ 20	2.17	272	68	1.0	-40 ~ 175
SCL120D-5	120	0.7	3165	≥ 6	≤ 20	2.21	272	68	1.0	-40 ~ 175
SCL220D-5	220	0.5	3265	≥ 6	≤ 20	4.12	272	68	1.0	-40 ~ 175

NTC

NTC

抑制浪涌电流NTC热敏电阻器

Inrush Current Limiting NTC Thermistor (NTC)

D-5系列 Series

电阻-温度曲线(仅供参考) R-T Characteristic Curves (For reference only)

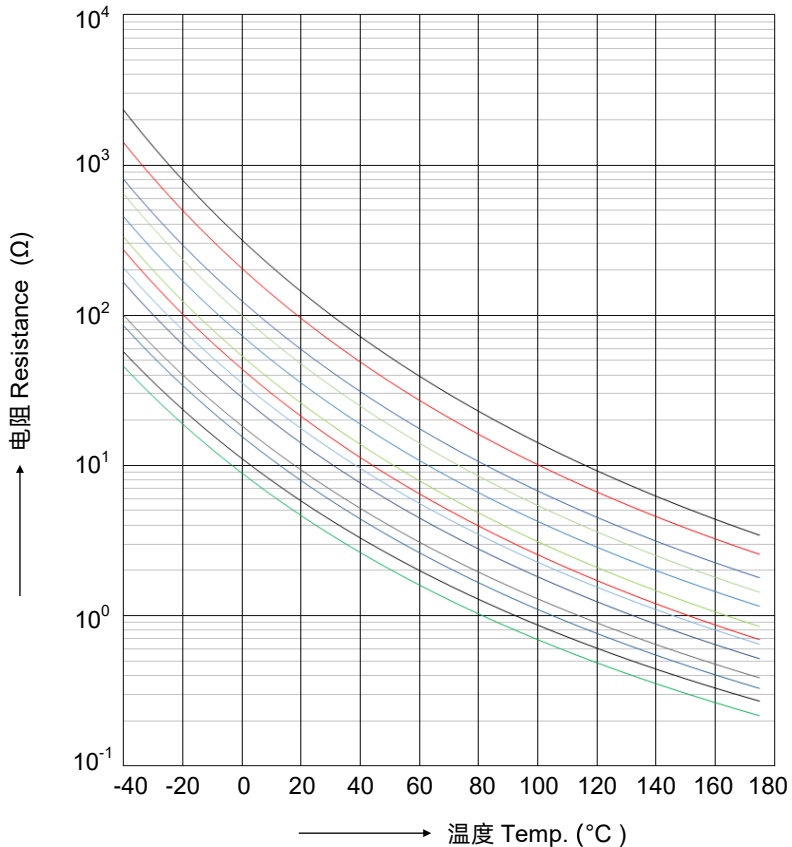
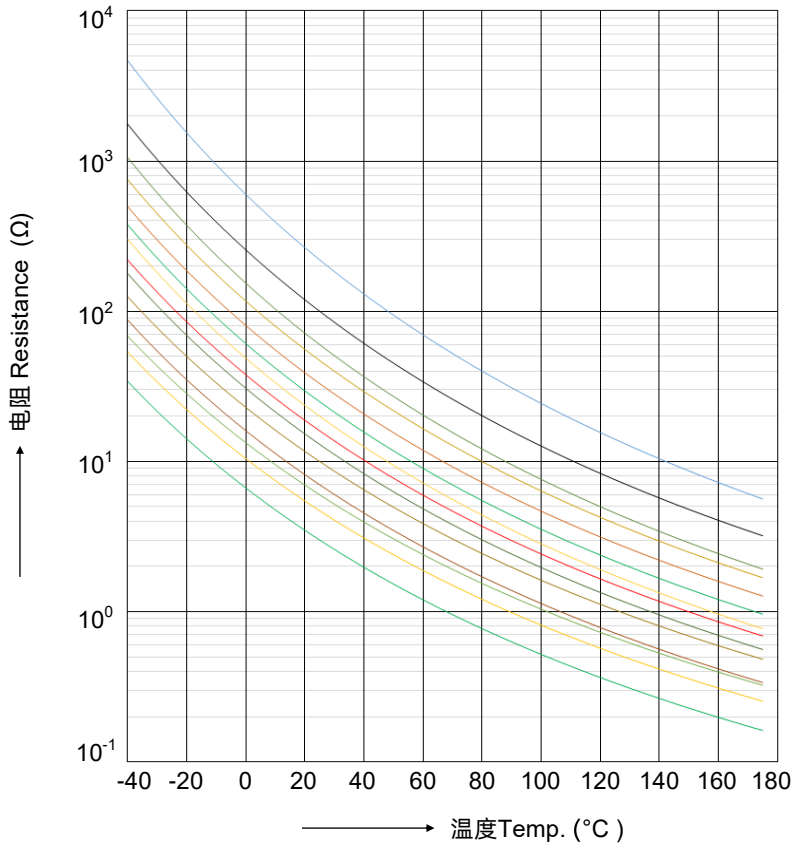

NTC

NTC

抑制浪涌电流NTC热敏电阻器

Inrush Current Limiting NTC Thermistor (NTC)

D-5系列 Series

电阻-电流曲线(仅供参考) Resistance & Current Curves (For reference only)

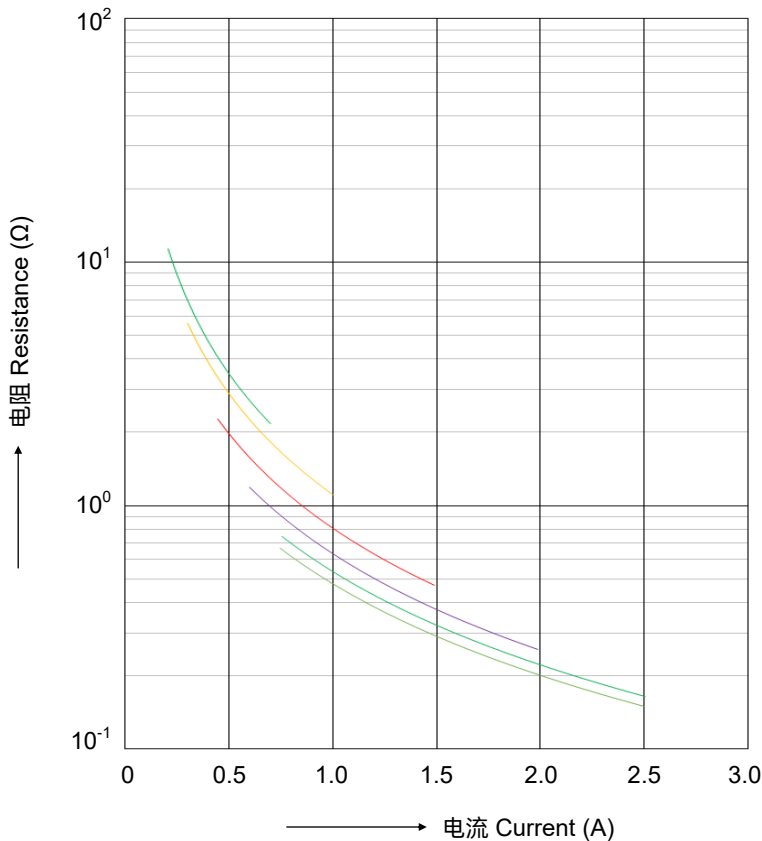
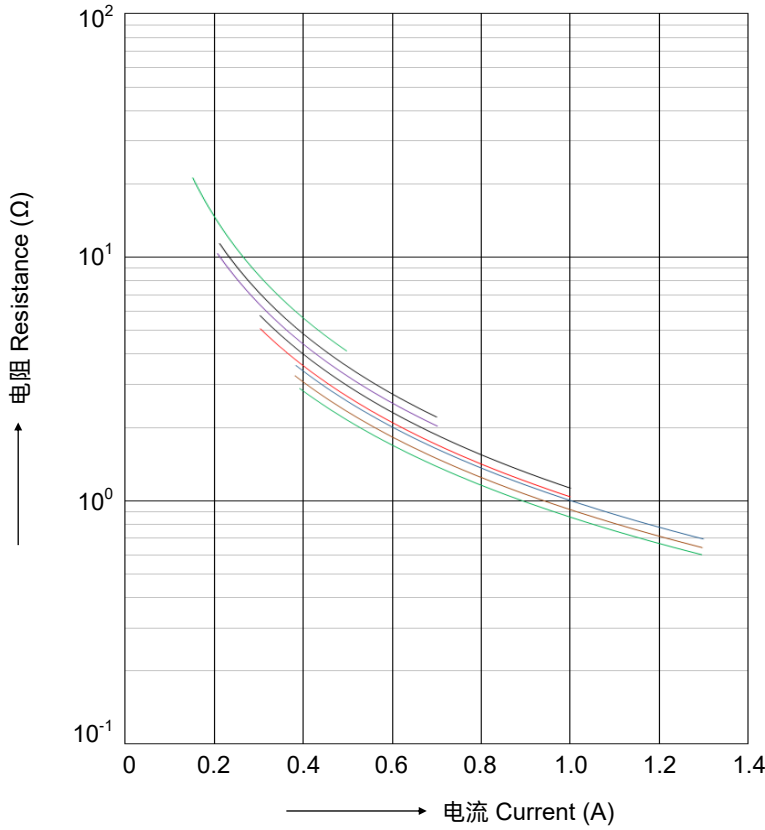

NTC

NTC

抑制浪涌电流NTC热敏电阻器

Inrush Current Limiting NTC Thermistor (NTC)

D-5系列 Series

电阻-电流曲线(仅供参考) Resistance & Current Curves (For reference only)

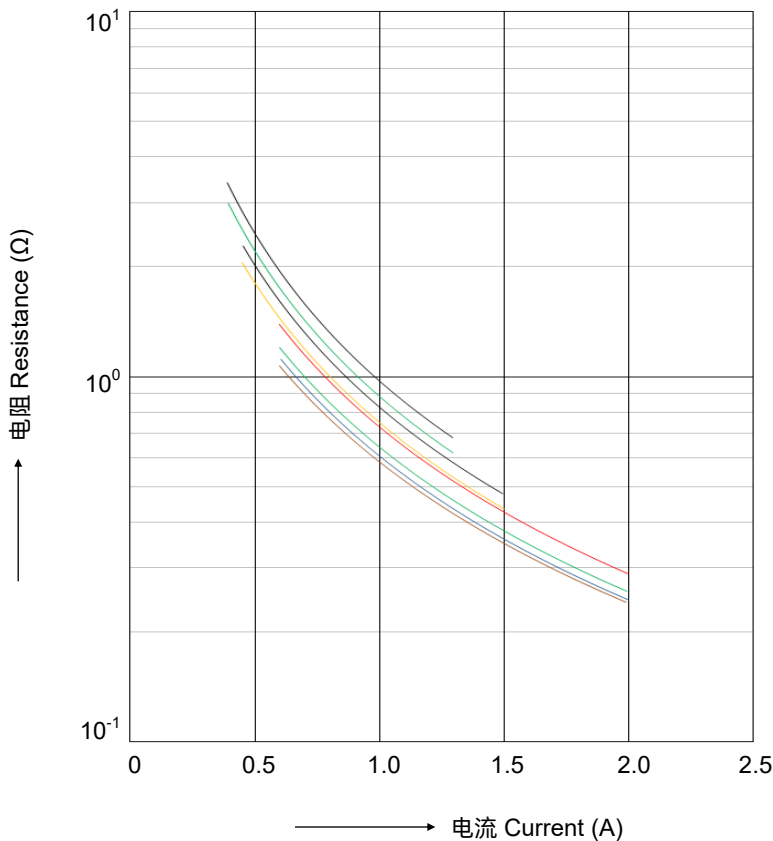
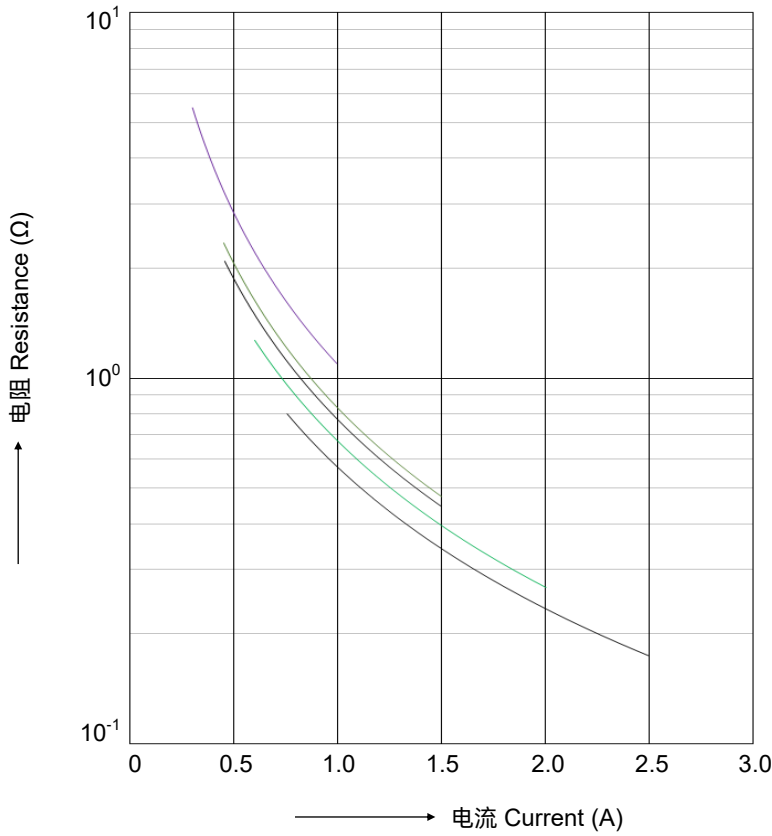

包装 Packaging

1. 散装 Bulk Packaging

项目 Item	PE袋 Bag	内盒 Inner Box	包装箱 Carton
尺寸 Dimensions (mm)	200 × 210	245 × 165 × 67	365 × 265 × 245
数量 Quantity (PCS)	1000	2000	12000

备注：包装尺寸及数量仅供参考

Remark: The dimensions of package and quantity are for reference only.

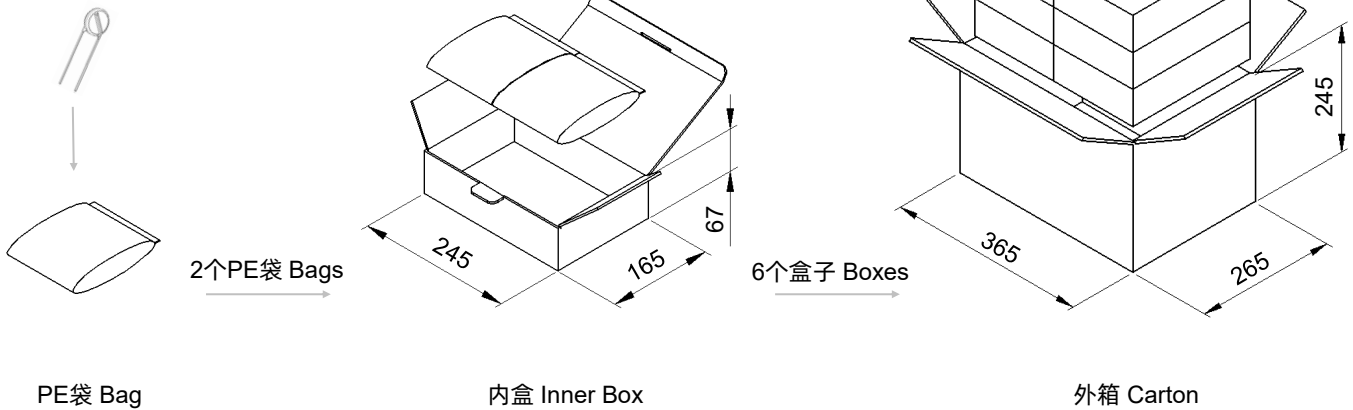

PE袋 Bag

内盒 Inner Box

外箱 Carton

抑制浪涌电流NTC热敏电阻器

Inrush Current Limiting NTC Thermistor (NTC)

D-5系列 Series

2. 折叠包装 Ammo Packing

2.1 尺寸和数量 Dimensions and Quantity

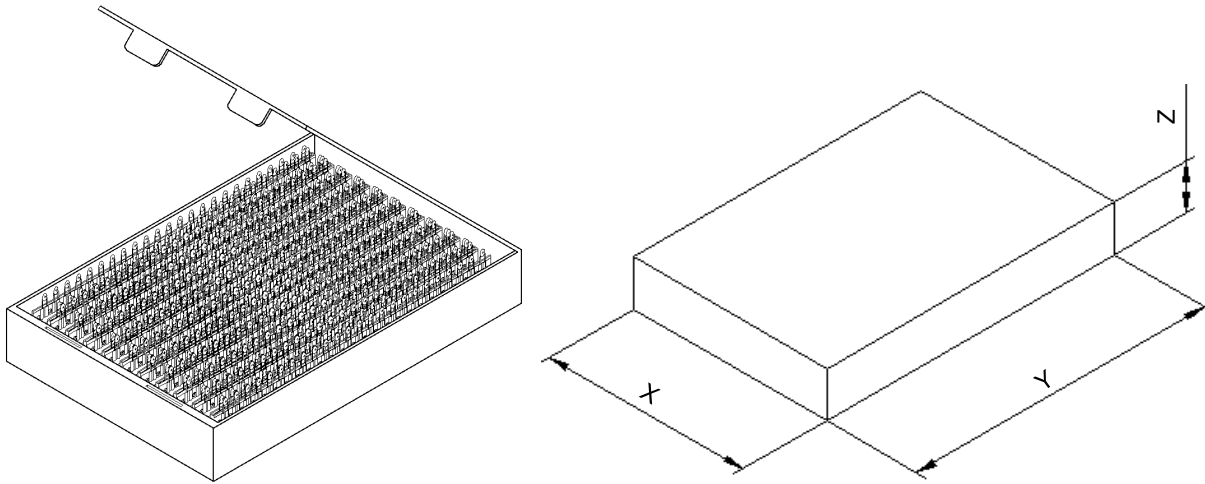

尺寸 Dimensions (mm)			数量 Quantity (PCS / Carton)
X	Y	Z	
235 Max.	345 Max.	55 Max.	1200

备注：包装尺寸及数量仅供参考
Remark: The dimensions of package and quantity are for reference only.

2.2 编带尺寸 Taping Dimensions (mm)

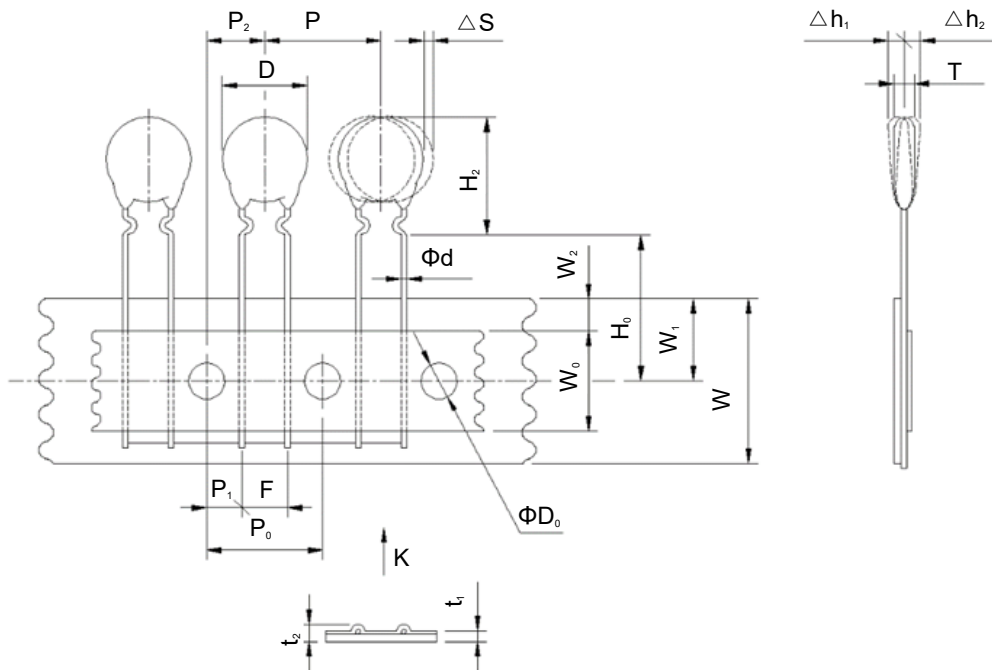

P	P ₀	F	P ₂	P ₁	D	ΔS	W	W ₁	H ₀
(12.7)	12.7 ± 0.3	5.0 ± 0.5	6.35 ± 1.3	3.85 ± 0.8	7.0 Max.	± 1.5	18.0 ± 1.0	9.0 ± 1.0	16.0 ± 1.0
H ₂	ΦD ₀	Φd	t ₁	t ₂	Δh ₁ , Δh ₂	W ₀	W ₂	T	
11.0 Max.	4.0 ± 0.3	0.6 ± 0.05	0.6 ± 0.3	2.0 Max.	1.5 Max.	10.0 Min.	4.0 Max.	5.0 Max.	